

# 1591H Enclosure

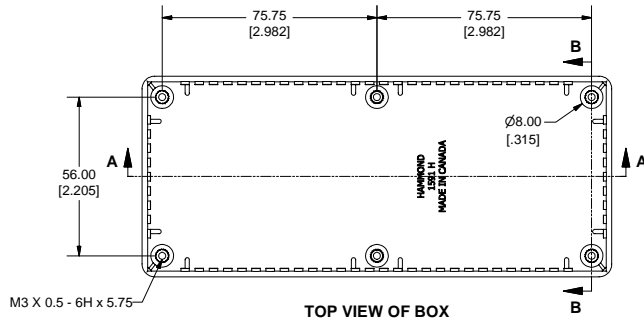

SIDE VIEW OF BOX



TOP VIEW OF BOX

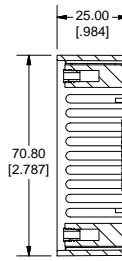

SECTION B-B

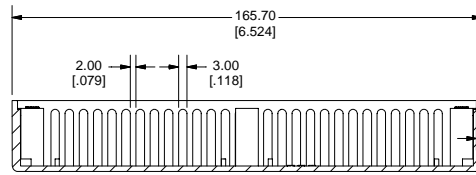

SECTION A-A

AVERAGE WALL THICKNESS  
1.90  
[.075]

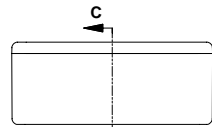

END VIEW OF ASSEMBLY

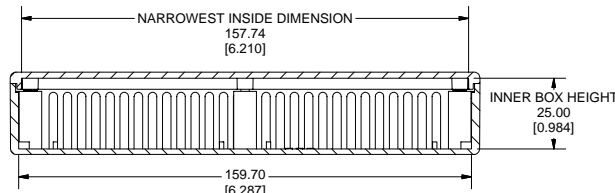

SECTION C-C

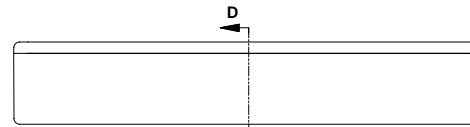

SIDEVIEW OF ASSEMBLY

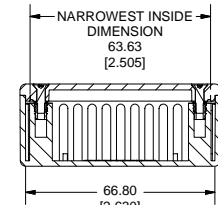

SECTION D-D

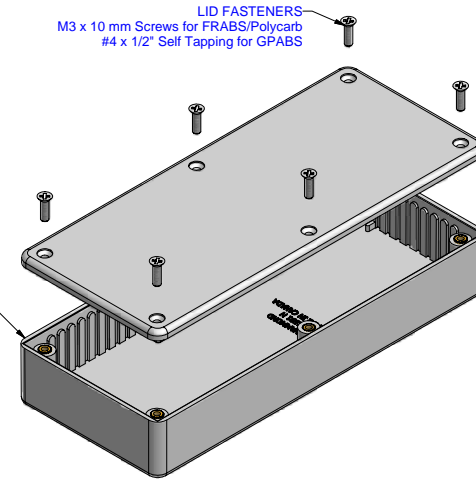

EXPLODED VIEW OF ASSEMBLY

Brass Inserts in FRABS and Polycarb  
No inserts in GPABS

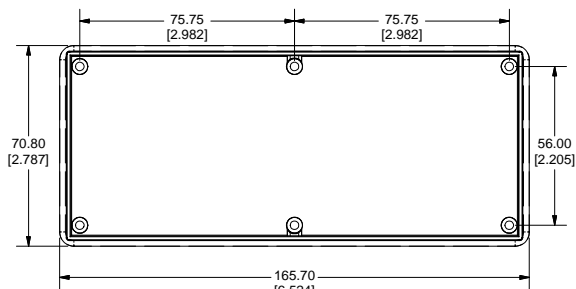

BOTTOM OF LID

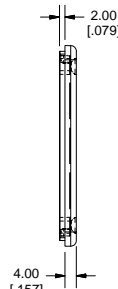

SIDE OF LID

**Note:**

Enclosures can be Factory Modified ( Milling, Drilling, Printing etc. )  
Solid models of this enclosure available in STEP or IGES Format.  
Contact Factory [mjm@hammondmfg.com](mailto:mjm@hammondmfg.com)



PART NUMBERS		
1591H Enclosures		
Material	Colour	Part Number
FR ABS UL94 - V0	Black	1591HBK
	Grey	1591HGY
	Black Shielded ( Conductive Paint )	1591RHBK
GP ABS	Black	1591HSBK
	Grey	1591HSGY
	Ice Blue	1591HTBU
Translucent Polycarbonate	IR Red	1591HTRD
	Crystal Clear	1591HTCL
Accessories		
	Description	Part Number
Universal Application	PC Board Card Adapters	See Accessories Section
	Flange Kits	See Accessories Section
	Clear Lids - clear, flame retardant polycarbonate - Lid ONLY	1591HC
FR ABS & Polycarbonate	Replacement Screws, Flat head Phillips, Nickel Plated Pkg of 100	1591MS100 (Black) 1591TS100
	GP ABS	Self Tapping Pkg of 100
Required Torque on Fasteners (no lubrication)		
	M3 - 0.5 x 10mm Screws	30-40 cN*m
	#4 x 0.5 Screws	30-40 cN*m